

## M12 S code male moldable connector, unshielded/M12, S型公头成型式连接器, 不带屏蔽

### Illustration/尺寸

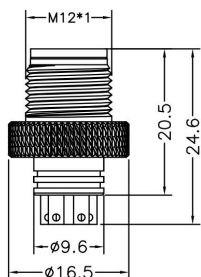

### Product photo/产品图



### Part number/产品料号

Pins/针数	Code/型	Part number/产品料号
4pins/4针	S code/S型	12C033

### Pin assignment front view/针位分布前视图

S code 4pins  
S型4针



### General data/常规数据

Pins Numbers/针数	4pins/4针
Rated voltage/额定电压	630V
Rated current(40°C)/额定电流	12A
Standards/标准	IEC 61076-2-101
Termination/焊接方式	solder/焊接
Degree of protection/防护等级	IP67, IP68, IP69K
Wire gauge(mm²)/线规(平方数)	0.14mm²-0.75mm²
Wire gauge(AWG)/线号(平方数)	26AWG-18AWG
Mechanical operation/插拔次数	>100 mating cycles/大于100次
Ambient temperature (operation)/操作温度	-25°C~+85°C
Contact resistance/接触电阻	≤5mΩ
Insulation resistance/绝缘电阻	≥100MΩ
Connector body/胶芯	TPU
Pins/端子	Brass with gold plated/黄铜镀金
Screw/螺丝	Brass with nickel plated/黄铜镀镍
Environmental compliance/环境符合标准	RoHs, Reach

## M12 S code female moldable connector, unshielded/M12, S型母头成型式连接器, 不带屏蔽

### Illustration/尺寸

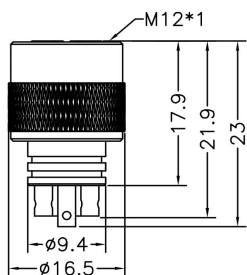

### Product photo/产品图



### Part number/产品料号

Pins/孔数	Code/型	Part number/产品料号
4pins/4针	S code/S型	12C034

### Pin assignment front view/孔位分布前视图

S code 4pins  
S型4孔



### General data/常规数据

Pins Numbers/孔数	4pins/4针
Rated voltage/额定电压	630V
Rated current(40°C)/额定电流	12A
Standards/标准	IEC 61076-2-101
Termination/焊接方式	solder/焊接
Degree of protection/防护等级	IP67, IP68, IP69K
Wire gauge(mm²)/线规(平方数)	0.14mm²-0.75mm²
Wire gauge(AWG)/线号(平方数)	26AWG-18AWG
Mechanical operation/插拔次数	>100 mating cycles/大于100次
Ambient temperature (operation)/操作温度	-25°C~+85°C
Contact resistance/接触电阻	≤5mΩ
Insulation resistance/绝缘电阻	≥100MΩ
Connector body/胶芯	TPU
Pins/端子	Phosphorus copper with gold plated/磷铜镀金
Screw/螺丝	Brass with nickel plated/黄铜镀镍
Gasket/胶圈	Fluorine ring/氟胶圈
Environmental compliance/环境符合标准	RoHs, Reach

## M12 S code male moldable connector with shielded/M12, S型公头成型式连接器, 带屏蔽

### Illustration/尺寸

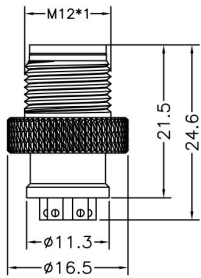

### Product photo/产品图



### Part number/产品料号

Pins/针数	Code/型	Part number/产品料号
4pins/4针	S code/S型	12C035

### Pin assignment front view/针位分布前视图

S code 4pins  
S型4针



### General data/常规数据

Pins Numbers/针数	4pins/4针
Rated voltage/额定电压	630V
Rated current(40°C)/额定电流	12A
Standards/标准	IEC 61076-2-101
Termination/焊接方式	solder/焊接
Degree of protection/防护等级	IP67, IP68, IP69K
Wire gauge(mm²)/线规(平方数)	0.14mm²-0.75mm²
Wire gauge(AWG)/线号(平方数)	26AWG-18AWG
Mechanical operation/插拔次数	>100 mating cycles/大于100次
Ambient temperature (operation)/操作温度	-25°C~+85°C
Contact resistance/接触电阻	≤5mΩ
Insulation resistance/绝缘电阻	≥100MΩ
Connector body/胶芯	TPU
Pins/端子	Brass with gold plated/黄铜镀金
Screw/螺丝	Brass with nickel plated/黄铜镀镍
Environmental compliance/环境符合标准	RoHs, Reach

## M12 S code female moldable connector with shielded/M12, S型母头成型式连接器, 带屏蔽

### Illustration/尺寸

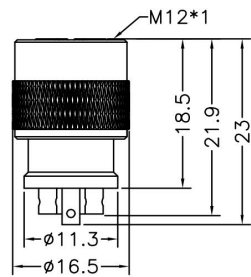

### Product photo/产品图



### Part number/产品料号

Pins/孔数	Code/型	Part number/产品料号
4pins/4针	S code/S型	12C036

### Pin assignment front view/孔位分布前视图

S code 4pins  
S型4孔



### General data/常规数据

Pins Numbers/孔数	4pins/4针
Rated voltage/额定电压	630V
Rated current(40°C)/额定电流	12A
Standards/标准	IEC 61076-2-101
Termination/焊接方式	solder/焊接
Degree of protection/防护等级	IP67, IP68, IP69K
Wire gauge(mm²)/线规(平方数)	0.14mm²-0.75mm²
Wire gauge(AWG)/线号(平方数)	26AWG-18AWG
Mechanical operation/插拔次数	>100 mating cycles/大于100次
Ambient temperature (operation)/操作温度	-25°C~+85°C
Contact resistance/接触电阻	≤5mΩ
Insulation resistance/绝缘电阻	≥100MΩ
Connector body/胶芯	TPU
Pins/端子	Phosphorus copper with gold plated/磷铜镀金
Screw/螺丝	Brass with nickel plated/黄铜镀镍
Gasket/胶圈	Fluorine ring/氟胶圈
Environmental compliance/环境符合标准	RoHs, Reach

## M12 S code male straight front panel mount connector, unshielded, insert/M12, S型公头直头前锁面板板端, 不带屏蔽

### Illustration/尺寸

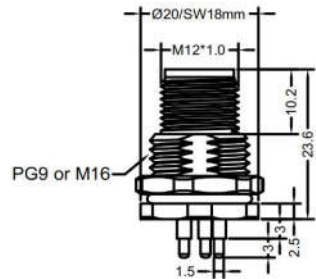

### Product photo/产品图



### Part number/产品料号

Pins/针数	Code/型	Part number/产品料号	
		PG9 thread 15.3±0.1/PG9螺纹15.3±0.1	M16 thread 16±0.1/M16螺纹16±0.1
4pins/4针	S code/S型	12B057	12B061

### Pin assignment front view/针位分布前视图

S code 4pins  
S型4针



### General data/常规数据

Pins Numbers/针数	4pins/4针
Rated voltage/额定电压	630V
Rated current(40°C)/额定电流	12A
Standards/标准	IEC 61076-2-101
Termination/焊接方式	solder PCB/PCB焊接
Connector locking system/锁紧方式	Screw/螺锁
Degree of protection/防护等级	IP67, IP68, IP69K
Mechanical operation/插拔次数	>100 mating cycles/大于100次
Ambient temperature (operation)/操作温度	-25°C~+85°C
Contact resistance/接触电阻	≤5mΩ
Insulation resistance/绝缘电阻	≥100MΩ
Connector body/胶芯	TPU
Pins/端子	Brass with gold plated/黄铜镀金
Screw/螺丝	Brass with nickel plated/黄铜镀镍
Gasket/胶圈	Fluorine ring/氟胶圈
Environmental compliance/环境符合标准	RoHs, Reach

## M12 S code female straight front panel mount connector, unshielded, insert/M12, S型母头直头前锁面板板端, 不带屏蔽

Illustration/尺寸

Product photo/产品图

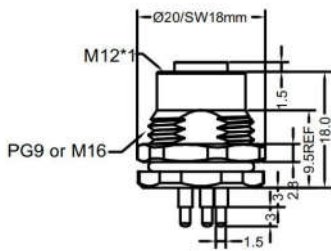

### Part number/产品料号

Pins/孔数	Code/型	Part number/产品料号	
		PG9 thread 15.3±0.1/PG9螺纹15.3±0.1	M16 thread 16±0.1/M16螺纹16±0.1
4pins/4针	S code/S型	12B059	12B063

### Pin assignment front view/孔位分布前视图

S code 4pins  
S型4孔



### General data/常规数据

Pins Numbers/孔数	4pins/4针
Rated voltage/额定电压	630V
Rated current(40°C)/额定电流	12A
Standards/标准	IEC 61076-2-101
Termination/焊接方式	solder PCB/PCB焊接
Connector locking system/锁紧方式	Screw/螺锁
Degree of protection/防护等级	IP67, IP68, IP69K
Mechanical operation/插拔次数	>100 mating cycles/大于100次
Ambient temperature (operation)/操作温度	-25°C~+85°C
Contact resistance/接触电阻	≤5mΩ
Insulation resistance/绝缘电阻	≥100MΩ
Connector body material/胶芯材料	TPU
Pins material/端子材料	Phosphorus copper with gold plated/磷铜镀金
Screw/螺丝材料	Brass with nickel plated/黄铜镀镍
Gasket material/胶圈材料	Fluorine ring/氟胶圈
Environmental compliance/环境符合标准	RoHs, Reach

**M12 S code male straight rear panel mount connector, unshielded, insert/M12, S型公头直头后锁面板板端, 不带屏蔽**

**Illustration/尺寸**

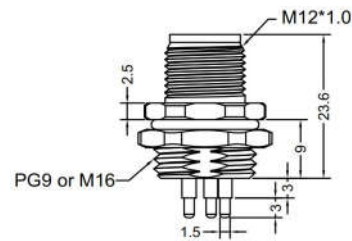

**Product photo/产品图**



**Part number/产品料号**

Pins/针数	Code/型	Part number/产品料号	
		PG9 thread 15.3±0.1/PG9螺纹15.3±0.1	M16 thread 16±0.1/M16螺纹16±0.1
4pins/4针	S code/S型	12B058	12B062

**Pin assignment front view/针位分布前视图**

S code 4pins  
S型4针



**General data/常规数据**

Pins Numbers/针数	4pins/4针
Rated voltage/额定电压	630V
Rated current(40°C)/额定电流	12A
Standards/标准	IEC 61076-2-101
Termination/焊接方式	solder PCB/PCB焊接
Connector locking system/锁紧方式	Screw/螺锁
Degree of protection/防护等级	IP67, IP68, IP69K
Mechanical operation/插拔次数	>100 mating cycles/大于100次
Ambient temperature (operation)/操作温度	-25°C~+85°C
Contact resistance/接触电阻	≤5mΩ
Insulation resistance/绝缘电阻	≥100MΩ
Connector body/胶芯	TPU
Pins/端子	Brass with gold plated/黄铜镀金
Screw/螺丝材料	Brass with nickel plated/黄铜镀镍
Gasket/胶圈	Fluorine ring/氟胶圈
Environmental compliance/环境符合标准	RoHs, Reach

**M12 S code female straight rear panel mount connector, unshielded, insert/M12, S型母头直头后锁面板板端, 不带屏蔽**

**Illustration/尺寸**

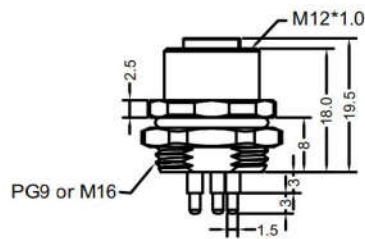

**Product photo/产品图**



**Part number/产品料号**

Pins/孔数	Code/型	Part number/产品料号	
		PG9 thread 15.3±0.1/PG9螺纹15.3±0.1	M16 thread 16±0.1/M16螺纹16±0.1
4pins/4针	S code/S型	12B060	12B064

**Pin assignment front view/孔位分布前视图**

S code 4pins  
S型4孔



**General data/常规数据**

Pins Numbers/孔数	4pins/4针
Rated voltage/额定电压	630V
Rated current(40°C)/额定电流	12A
Standards/标准	IEC 61076-2-101
Termination/焊接方式	solder PCB/PCB焊接
Connector locking system/锁紧方式	Screw/螺锁
Degree of protection/防护等级	IP67, IP68, IP69K
Mechanical operation/插拔次数	>100 mating cycles/大于100次
Ambient temperature (operation)/操作温度	-25°C~+85°C
Contact resistance/接触电阻	≤5mΩ
Insulation resistance/绝缘电阻	≥100MΩ
Connector body/胶芯	TPU
Pins/端子	Phosphorus copper with gold plated/磷铜镀金
Screw/螺丝	Brass with nickel plated/黄铜镀镍
Gasket/胶圈	Fluorine ring/氟胶圈
Environmental compliance/环境符合标准	RoHs, Reach



M12 S code male straight front panel mount connector, unshielded, solder/M12, S型公头直头前锁面板焊线式, 不带屏蔽

## Illustration/尺寸

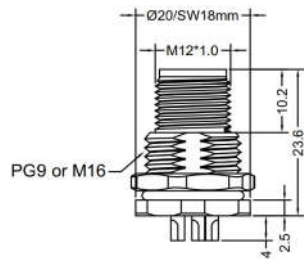

## Product photo/产品图



## Part number/产品料号

Pins/针数	Code/型	Part number("X" is length millimetre mm)/产品料号("X"表示长度, 单位毫米mm)	
		PG9 thread 15.3±0.1/PG9螺纹15.3±0.1	M16 thread 16±0.1/M16螺纹16±0.1
4pins/4针	S code/S型	12H057	12H131

## Pin assignment front view/针位分布前视图

S code 4pins  
S型4针



## General data/常规数据

Pins Numbers/针数	4pins/4针
Rated voltage/额定电压	630V
Rated current(40°C)/额定电流	12A
Standards/标准	IEC 61076-2-101
Termination/焊接方式	solder/焊接
Connector locking system/锁紧方式	Screw/螺锁
Degree of protection/防护等级	IP67, IP68, IP69K
Wire gauge(mm²)/线规(平方数)	0.14mm²-0.75mm²
Wire gauge(AWG)/线号(平方数)	26AWG-18AWG
Mechanical operation/插拔次数	>100 mating cycles/大于100次
Ambient temperature (operation)/操作温度	-40°C~+85°C
Contact resistance/接触电阻	≤5mΩ
Insulation resistance/绝缘电阻	≥100MΩ
Connector body/胶芯	TPU
Pins/端子	Brass with gold plated/黄铜镀金
Screw/螺丝	Brass with nickel plated/黄铜镀镍
Gasket/胶圈	Fluorine ring/氟胶圈
Environmental compliance/环境符合标准	RoHs, Reach

## M12 S code female straight front panel mount connector, unshielded, solder/M12, S型母头直头前锁面板焊线式, 不带屏蔽

### Illustration/尺寸

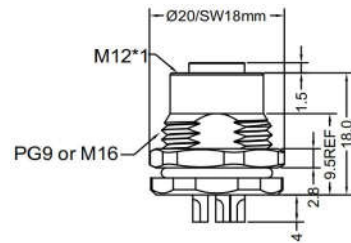

### Product photo/产品图



### Part number/产品料号

Pins/孔数	Code/型	Part number("X" is length millimetre mm)/产品料号("X"表示长度, 单位毫米mm)	
4pins/4针	S code/S型	PG9 thread 15.3±0.1/PG9螺纹15.3±0.1	M16 thread 16±0.1/M16螺纹16±0.1
		12H059	12H063

### Pin assignment front view/孔位分布前视图

S code 4pins  
S型4孔



### General data/常规数据

Pins Numbers/孔数	4pins/4针
Rated voltage/额定电压	630V
Rated current(40°C)/额定电流	12A
Standards/标准	IEC 61076-2-101
Termination/焊接方式	solder/焊接
Connector locking system/锁紧方式	Screw/螺锁
Degree of protection/防护等级	IP67, IP68, IP69K
Wire gauge(mm²)/线规(平方数)	0.14mm²-0.75mm²
Wire gauge(AWG)/线号(平方数)	26AWG-18AWG
Mechanical operation/插拔次数	>100 mating cycles/大于100次
Ambient temperature (operation)/操作温度	-40°C~+85°C
Contact resistance/接触电阻	≤5mΩ
Insulation resistance/绝缘电阻	≥100MΩ
Connector body/胶芯	TPU
Pins/端子	Phosphorus copper with gold plated/磷铜镀金
Screw/螺丝	Brass with nickel plated/黄铜镀镍
Gasket/胶圈	Fluorine ring/氟胶圈
Environmental compliance/环境符合标准	RoHs, Reach

## M12 S code male straight rear panel mount connector, unshielded, solder/M12, S型公头直头后横面板焊线式, 不带屏蔽

### Illustration/尺寸

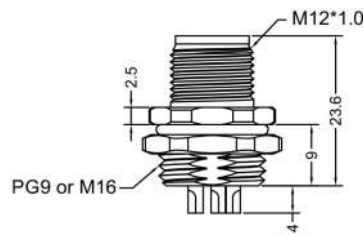

### Product photo/产品图



### Part number/产品料号

Pins/针数	Code/型	Part number("X" is length millimetre mm)/产品料号("X"表示长度, 单位毫米mm)	
4pins/4针	S code/S型	PG9 thread 15.3±0.1/PG9螺纹15.3±0.1	M16 thread 16±0.1/M16螺纹16±0.1
		12H058	12H132

### Pin assignment front view/针位分布前视图

S code 4pins  
S型4针



### General data/常规数据

Pins Numbers/针数	4pins/4针
Rated voltage/额定电压	630V
Rated current(40°C)/额定电流	12A
Standards/标准	IEC 61076-2-101
Termination/焊接方式	solder/焊接
Connector locking system/锁紧方式	Screw/螺锁
Degree of protection/防护等级	IP67, IP68, IP69K
Wire gauge(mm²)/线规(平方数)	0.14mm²-0.75mm²
Wire gauge(AWG)/线号(平方数)	26AWG-18AWG
Mechanical operation/插拔次数	>100 mating cycles/大于100次
Ambient temperature (operation)/操作温度	-40°C~+85°C
Contact resistance/接触电阻	≤5mΩ
Insulation resistance/绝缘电阻	≥100MΩ
Connector body/胶芯	TPU
Pins/端子	Brass with gold plated/黄铜镀金
Screw/螺丝	Brass with nickel plated/黄铜镀镍
Gasket/胶圈	Fluorine ring/氟胶圈
Environmental compliance/环境符合标准	RoHs, Reach

## M12 S code female straight rear panel mount connector, unshielded, solder/M12, S型母头直头后锁面板焊线式, 不带屏蔽

### Illustration/尺寸

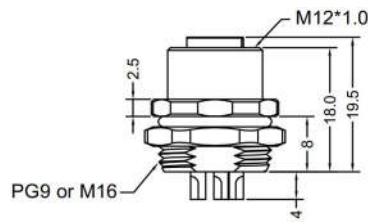

### Product photo/产品图



### Part number/产品料号

Pins/孔数	Code/型	Part number("X" is length millimetre mm)/产品料号("X"表示长度, 单位毫米mm)	
4pins/4针	S code/S型	PG9 thread 15.3±0.1/PG9螺纹15.3±0.1	M16 thread 16±0.1/M16螺纹16±0.1
		12H060	12H064

### Pin assignment front view/孔位分布前视图

S code 4pins  
S型4孔



### General data/常规数据

Pins Numbers/孔数	4pins/4针
Rated voltage/额定电压	630V
Rated current(40°C)/额定电流	12A
Standards/标准	IEC 61076-2-101
Termination/焊接方式	solder/焊接
Connector locking system/锁紧方式	Screw/螺锁
Degree of protection/防护等级	IP67, IP68, IP69K
Wire gauge(mm²)/线规(平方数)	0.14mm²-0.75mm²
Wire gauge(AWG)/线号(平方数)	26AWG-18AWG
Mechanical operation/插拔次数	>100 mating cycles/大于100次
Ambient temperature (operation)/操作温度	-40°C~+85°C
Contact resistance/接触电阻	≤5mΩ
Insulation resistance/绝缘电阻	≥100MΩ
Connector body/胶芯	TPU
Pins/端子	Phosphorus copper with gold plated/磷铜镀金
Screw/螺丝	Brass with nickel plated/黄铜镀镍
Gasket/胶圈	Fluorine ring/氟胶圈
Environmental compliance/环境符合标准	RoHs, Reach

## M12 S code male straight front panel mount connector, unshielded, single wires/M12, S型公头直头前锁面板带线, 不带屏蔽

### Illustration/尺寸

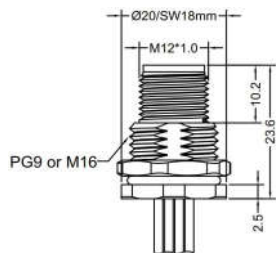

### Product photo/产品图



### Part number/产品料号

Pins/针数	Code/型	Part number("X" is length millimetre mm)/产品料号("X"表示长度, 单位毫米mm)	
		PG9 thread 15.3±0.1/PG9螺纹15.3±0.1	M16 thread 16±0.1/M16螺纹16±0.1
4pins/4针	S code/S型	12D057	12D061

### Pin assignment front view/针位分布前视图

S code 4pins  
S型4针



### General data/常规数据

Pins Numbers/针数	4pins/4针
Rated voltage/额定电压	630V
Rated current(40°C)/额定电流	12A
Standards/标准	IEC 61076-2-101
Termination/焊接方式	solder/焊接
Connector locking system/锁紧方式	Screw/螺锁
Degree of protection/防护等级	IP67, IP68, IP69K
Wire gauge(mm²)/线规(平方数)	0.14mm²-0.75mm²
Wire gauge(AWG)/线号(平方数)	26AWG-18AWG
Mechanical operation/插拔次数	>100 mating cycles/大于100次
Ambient temperature (operation)/操作温度	-40°C~+85°C
Contact resistance/接触电阻	≤5mΩ
Insulation resistance/绝缘电阻	≥100MΩ
Connector body/胶芯	TPU
Pins/端子	Brass with gold plated/黄铜镀金
Screw/螺丝	Brass with nickel plated/黄铜镀镍
Gasket/胶圈	Fluorine ring/氟胶圈
Environmental compliance/环境符合标准	RoHs, Reach

## M12 S code female straight front panel mount connector, unshielded, single wires/M12, S型母头直头前锁面板带线, 不带屏蔽

### Illustration/尺寸

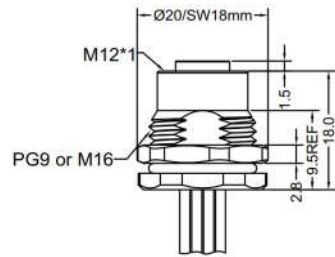

### Product photo/产品图



### Part number/产品料号

Pins/孔数	Code/型	Part number("X" is length millimetre mm)/产品料号("X"表示长度, 单位毫米mm)	
		PG9 thread 15.3±0.1/PG9螺纹15.3±0.1	M16 thread 16±0.1/M16螺纹16±0.1
4pins/4针	S code/S型	12D059	12D063

### Pin assignment front view/孔位分布前视图

S code 4pins  
S型4孔



### General data/常规数据

Pins Numbers/孔数	4pins/4针
Rated voltage/额定电压	630V
Rated current(40°C)/额定电流	12A
Standards/标准	IEC 61076-2-101
Termination/焊接方式	solder/焊接
Connector locking system/锁紧方式	Screw/螺锁
Degree of protection/防护等级	IP67, IP68, IP69K
Wire gauge(mm²)/线规(平方数)	0.14mm²-0.75mm²
Wire gauge(AWG)/线号(平方数)	26AWG-18AWG
Mechanical operation/插拔次数	>100 mating cycles/大于100次
Ambient temperature (operation)/操作温度	-40°C~+85°C
Contact resistance/接触电阻	≤5mΩ
Insulation resistance/绝缘电阻	≥100MΩ
Connector body/胶芯	TPU
Pins/端子	Phosphorus copper with gold plated/磷铜镀金
Screw/螺丝	Brass with nickel plated/黄铜镀镍
Gasket/胶圈	Fluorine ring/氟胶圈
Environmental compliance/环境符合标准	RoHs, Reach

**M12 S code male straight rear panel mount connector, unshielded, single wires/M12, S型公头直头后锁面板带线, 不带屏蔽**

**Illustration/尺寸**

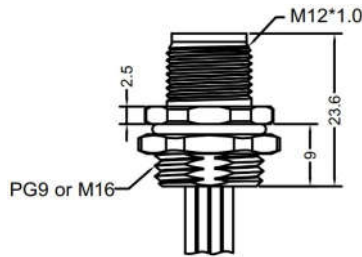

**Product photo/产品图**



**Part number/产品料号**

Pins/针数	Code/型	Part number("X" is length millimetre mm)/产品料号("X"表示长度, 单位毫米mm)	
4pins/4针	S code/S型	PG9 thread 15.3±0.1/PG9螺纹15.3±0.1	M16 thread 16±0.1/M16螺纹16±0.1
		12D058	12D062

**Pin assignment front view/针位分布前视图**

S code 4pins  
S型4针



**General data/常规数据**

Pins Numbers/针数	4pins/4针
Rated voltage/额定电压	630V
Rated current(40°C)/额定电流	12A
Standards/标准	IEC 61076-2-101
Termination/焊接方式	solder/焊接
Connector locking system/锁紧方式	Screw/螺锁
Degree of protection/防护等级	IP67, IP68, IP69K
Wire gauge(mm²)/线规(平方数)	0.14mm²-0.75mm²
Wire gauge(AWG)/线号(平方数)	26AWG-18AWG
Mechanical operation/插拔次数	>100 mating cycles/大于100次
Ambient temperature (operation)/操作温度	-40°C~+85°C
Contact resistance/接触电阻	≤5mΩ
Insulation resistance/绝缘电阻	≥100MΩ
Connector body/胶芯	TPU
Pins/端子	Brass with gold plated/黄铜镀金
Screw/螺丝	Brass with nickel plated/黄铜镀镍
Gasket/胶圈	Fluorine ring/氟胶圈
Environmental compliance/环境符合标准	RoHs, Reach

## M12 S code female straight rear panel mount connector, unshielded, single wires/M12, S型母头直头后锁面板带线, 不带屏蔽

### Illustration/尺寸

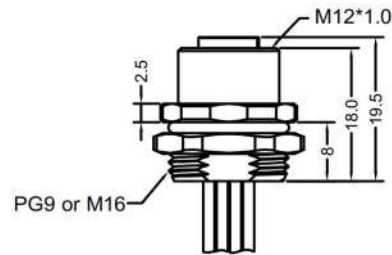

### Product photo/产品图



### Part number/产品料号

Pins/孔数	Code/型	Part number("X" is length millimetre mm)/产品料号("X"表示长度, 单位毫米mm)	
		PG9 thread 15.3±0.1/PG9螺纹15.3±0.1	M16 thread 16±0.1/M16螺纹16±0.1
4pins/4针	S code/S型	12D060	12D064

### Pin assignment front view/孔位分布前视图

S code 4pins  
S型4孔



### General data/常规数据

Pins Numbers/孔数	4pins/4针
Rated voltage/额定电压	630V
Rated current(40°C)/额定电流	12A
Standards/标准	IEC 61076-2-101
Termination/焊接方式	solder/焊接
Connector locking system/锁紧方式	Screw/螺锁
Degree of protection/防护等级	IP67, IP68, IP69K
Wire gauge(mm²)/线规(平方数)	0.14mm²-0.75mm²
Wire gauge(AWG)/线号(平方数)	26AWG-18AWG
Mechanical operation/插拔次数	>100 mating cycles/大于100次
Ambient temperature (operation)/操作温度	-40°C~+85°C
Contact resistance/接触电阻	≤5mΩ
Insulation resistance/绝缘电阻	≥100MΩ
Connector body/胶芯	TPU
Pins/端子	Phosphorus copper with gold plated/磷铜镀金
Screw/螺丝	Brass with nickel plated/黄铜镀镍
Gasket/胶圈	Fluorine ring/氟胶圈
Environmental compliance/环境符合标准	RoHs, Reach



## M12 S code male straight molded cable, unshielded/M12, S型公头直头成型式连接线, 不带屏蔽

### Illustration/尺寸



### Product photo/产品图



### Part number/产品料号

Pins/针数	Code/型	Part number("X" is length millimetre mm)/产品料号("X"表示长度, 单位毫米mm)	
		PVC jacket/PVC外被	PUR jacket/PUR外被
4pins/4针	S code/S型	-40°C~+105°C	-40°C~+105°C
		12L01672-X	12L00132-X

### Pin assignment front view/针位分布前视图

S code 4pins  
S型4针



### General data/常规数据

Pins Numbers/针数	4pins/4针
Rated voltage/额定电压	630V
Rated current(40°C)/额定电流	12A
Standards/标准	IEC 61076-2-101
Termination/焊接方式	solder and over-mold/焊接和成型
Degree of protection/防护等级	IP67, IP68, IP69K
Wire gauge(mm²)/线规(平方数)	0.14mm²-0.75mm²
Wire gauge(AWG)/线号(平方数)	26AWG-18AWG
Mechanical operation/插拔次数	>100 mating cycles/大于100次
Contact resistance/接触电阻	≤5mΩ
Insulation resistance/绝缘电阻	≥100MΩ
Connector body/胶芯	TPU
Pins/端子	Brass with gold plated/黄铜镀金
Screw/螺丝	Brass with nickel plated/黄铜镀镍
Environmental compliance/环境符合标准	RoHs, Reach

## M12 S code female straight molded cable, unshielded/M12, S型母头直头成型式连接线, 不带屏蔽

### Illustration/尺寸

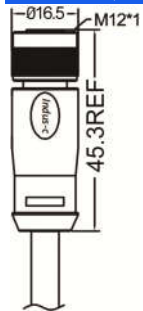

### Product photo/产品图



### Part number/产品料号

Pins/孔数	Code/型	Part number("X" is length millimetre mm)/产品料号("X"表示长度, 单位毫米mm)	
		PVC jacket/PVC外被	PUR jacket/PUR外被
4pins/4针	S code/S型	-40°C~+105°C	-40°C~+105°C
		12L01673-X	12L00133-X

### Pin assignment front view/孔位分布前视图

S code 4pins  
S型4孔



### General data/常规数据

Pins Numbers/孔数	4pins/4针
Rated voltage/额定电压	630V
Rated current(40°C)/额定电流	12A
Standards/标准	IEC 61076-2-101
Termination/焊接方式	solder and over-mold/焊接和成型
Degree of protection/防护等级	IP67, IP68, IP69K
Wire gauge(mm²)/线规(平方数)	0.14mm²-0.75mm²
Wire gauge(AWG)/线号(平方数)	26AWG-18AWG
Mechanical operation/插拔次数	>100 mating cycles/大于100次
Contact resistance/接触电阻	≤5mΩ
Insulation resistance/绝缘电阻	≥100MΩ
Connector body/胶芯	TPU
Pins/端子	Phosphorus copper with gold plated/磷铜镀金
Screw/螺丝	Brass with nickel plated/黄铜镀镍
Environmental compliance/环境符合标准	RoHs, Reach

## M12 S code male straight molded cable, shielded/M12, S型公头直头成型式连接线, 带屏蔽

### Illustration/尺寸

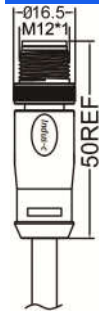

### Product photo/产品图



### Part number/产品料号

Pins/针数	Code/型	Part number("X" is length millimetre mm)/产品料号("X"表示长度, 单位毫米mm)	
		PVC jacket/PVC外被	PUR jacket/PUR外被
4pins/4针	S code/S型	-40°C~+105°C	-40°C~+105°C
		12L01676-X	12L01626-X

### Pin assignment front view/针位分布前视图

S code 4pins  
S型4针



### General data/常规数据

Pins Numbers/针数	4pins/4针
Rated voltage/额定电压	630V
Rated current(40°C)/额定电流	12A
Standards/标准	IEC 61076-2-101
Termination/焊接方式	solder and over-mold/焊接和成型
Degree of protection/防护等级	IP67, IP68, IP69K
Wire gauge(mm²)/线规(平方数)	0.14mm²-0.75mm²
Wire gauge(AWG)/线号(平方数)	26AWG-18AWG
Mechanical operation/插拔次数	>100 mating cycles/大于100次
Contact resistance/接触电阻	≤5mΩ
Insulation resistance/绝缘电阻	≥100MΩ
Connector body/胶芯	TPU
Pins/端子	Brass with gold plated/黄铜镀金
Screw/螺丝	Brass with nickel plated/黄铜镀镍
Environmental compliance/环境符合标准	RoHs, Reach

## M12 S code female straight molded cable, shielded/M12, S型母头直头成型式连接线, 带屏蔽

### Illustration/尺寸

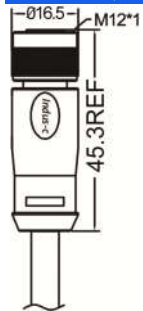

### Product photo/产品图



### Part number/产品料号

Pins/孔数	Code/型	Part number("X" is length millimetre mm)/产品料号("X"表示长度, 单位毫米mm)	
		PVC jacket/PVC外被	PUR jacket/PUR外被
4pins/4针	S code/S型	-40°C~+105°C	-40°C~+105°C
		12L01677-X	12L01627-X

### Pin assignment front view/孔位分布前视图

S code 4pins  
S型4孔



### General data/常规数据

Pins Numbers/孔数	4pins/4针
Rated voltage/额定电压	630V
Rated current(40°C)/额定电流	12A
Standards/标准	IEC 61076-2-101
Termination/焊接方式	solder and over-mold/焊接和成型
Degree of protection/防护等级	IP67, IP68, IP69K
Wire gauge(mm²)/线规(平方数)	0.14mm²-0.75mm²
Wire gauge(AWG)/线号(平方数)	26AWG-18AWG
Mechanical operation/插拔次数	>100 mating cycles/大于100次
Contact resistance/接触电阻	≤5mΩ
Insulation resistance/绝缘电阻	≥100MΩ
Connector body/胶芯	TPU
Pins/端子	Phosphorus copper with gold plated/磷铜镀金
Screw/螺丝	Brass with nickel plated/黄铜镀镍
Environmental compliance/环境符合标准	RoHs, Reach

## M12 S code male right angle molded cable, unshielded/M12, S型公头弯头成型式连接线, 不带屏蔽

Illustration/尺寸

Product photo/产品图

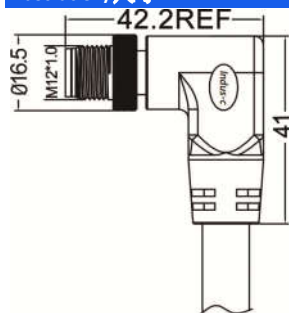

Part number/产品料号

Pins/针数	Code/型	Part number("X" is length millimetre mm)/产品料号("X"表示长度, 单位毫米mm)	
		PVC jacket/PVC外被	PUR jacket/PUR外被
4pins/4针	S code/S型	-40°C~+105°C	-40°C~+105°C
		12L01674-X	12L01628-X

Pin assignment front view/针位分布前视图

S code 4pins  
S型4针



General data/常规数据

Pins Numbers/针数	4pins/4针
Rated voltage/额定电压	630V
Rated current(40°C)/额定电流	12A
Standards/标准	IEC 61076-2-101
Termination/焊接方式	solder and over-mold/焊接和成型
Degree of protection/防护等级	IP67, IP68, IP69K
Wire gauge(mm²)/线规(平方数)	0.14mm²-0.75mm²
Wire gauge(AWG)/线号(平方数)	26AWG-18AWG
Mechanical operation/插拔次数	>100 mating cycles/大于100次
Contact resistance/接触电阻	≤5mΩ
Insulation resistance/绝缘电阻	≥100MΩ
Connector body/胶芯	TPU
Pins/端子	Brass with gold plated/黄铜镀金
Screw/螺丝	Brass with nickel plated/黄铜镀镍
Environmental compliance/环境符合标准	RoHs, Reach

**M12 S code female right angle molded cable, unshielded/M12, S型母头弯头成型式连接线, 不带屏蔽**

**Illustration/尺寸**

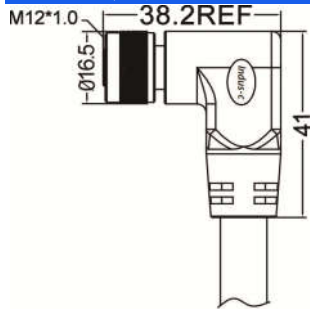

**Product photo/产品图**



**Part number/产品料号**

Pins/孔数	Code/型	Part number("X" is length millimetre mm)/产品料号("X"表示长度, 单位毫米mm)	
		PVC jacket/PVC外被	PUR jacket/PUR外被
4pins/4针	S code/S型	-40°C~+105°C	-40°C~+105°C
		12L01675-X	12L01629-X

**Pin assignment front view/孔位分布前视图**

S code 4pins  
S型4孔



**General data/常规数据**

Pins Numbers/孔数	4pins/4针
Rated voltage/额定电压	630V
Rated current(40°C)/额定电流	12A
Standards/标准	IEC 61076-2-101
Termination/焊接方式	solder and over-mold/焊接和成型
Degree of protection/防护等级	IP67, IP68, IP69K
Wire gauge(mm²)/线规(平方数)	0.14mm²-0.75mm²
Wire gauge(AWG)/线号(平方数)	26AWG-18AWG
Mechanical operation/插拔次数	>100 mating cycles/大于100次
Contact resistance/接触电阻	≤5mΩ
Insulation resistance/绝缘电阻	≥100MΩ
Connector body/胶芯	TPU
Pins/端子	Phosphorus copper with gold plated/磷铜镀金
Screw/螺丝	Brass with nickel plated/黄铜镀镍
Environmental compliance/环境符合标准	RoHs, Reach

## M12 S code male right angle molded cable, shielded/M12, S型公头弯头成型式连接线, 带屏蔽

### Illustration/尺寸

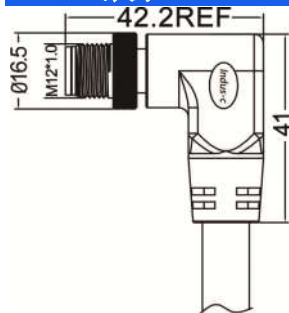

### Product photo/产品图



### Part number/产品料号

Pins/针数	Code/型	Part number("X" is length millimetre mm)/产品料号("X"表示长度, 单位毫米mm)	
		PVC jacket/PVC外被	PUR jacket/PUR外被
4pins/4针	S code/S型	-40°C~+105°C	-40°C~+105°C
		12L01678-X	12L01630-X

### Pin assignment front view/针位分布前视图

S code 4pins  
S型4针



### General data/常规数据

Pins Numbers/针数	4pins/4针
Rated voltage/额定电压	630V
Rated current(40°C)/额定电流	12A
Standards/标准	IEC 61076-2-101
Termination/焊接方式	solder and over-mold/焊接和成型
Degree of protection/防护等级	IP67, IP68, IP69K
Wire gauge(mm²)/线规(平方数)	0.14mm²-0.75mm²
Wire gauge(AWG)/线号(平方数)	26AWG-18AWG
Mechanical operation/插拔次数	>100 mating cycles/大于100次
Contact resistance/接触电阻	≤5mΩ
Insulation resistance/绝缘电阻	≥100MΩ
Connector body/胶芯	TPU
Pins/端子	Brass with gold plated/黄铜镀金
Screw/螺丝	Brass with nickel plated/黄铜镀镍
Environmental compliance/环境符合标准	RoHs, Reach

## M12 S code female right angle molded cable, shielded/M12, S型母头弯头成型式连接线, 带屏蔽

### Illustration/尺寸

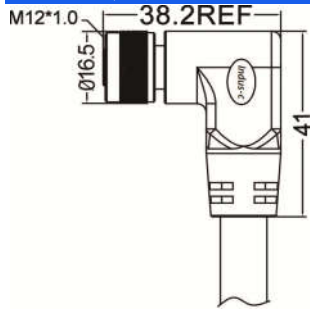

### Product photo/产品图



### Part number/产品料号

Pins/孔数	Code/型	Part number("X" is length millimetre mm)/产品料号("X"表示长度, 单位毫米mm)	
		PVC jacket/PVC外被	PUR jacket/PUR外被
4pins/4针	S code/S型	-40°C~+105°C	-40°C~+105°C
		12L01679-X	12L01631-X

### Pin assignment front view/孔位分布前视图

S code 4pins  
S型4孔



### General data/常规数据

Pins Numbers/孔数	4pins/4针
Rated voltage/额定电压	630V
Rated current(40°C)/额定电流	12A
Standards/标准	IEC 61076-2-101
Termination/焊接方式	solder and over-mold/焊接和成型
Degree of protection/防护等级	IP67, IP68, IP69K
Wire gauge(mm²)/线规(平方数)	0.14mm²-0.75mm²
Wire gauge(AWG)/线号(平方数)	26AWG-18AWG
Mechanical operation/插拔次数	>100 mating cycles/大于100次
Contact resistance/接触电阻	≤5mΩ
Insulation resistance/绝缘电阻	≥100MΩ
Connector body/胶芯	TPU
Pins/端子	Phosphorus copper with gold plated/磷铜镀金
Screw/螺丝	Brass with nickel plated/黄铜镀镍
Environmental compliance/环境符合标准	RoHs, Reach



**M12 S code male to male right angle molded cable, unshielded/M12, S型公头弯头对公头弯头连接线, 不带屏蔽**

**Illustration/尺寸**

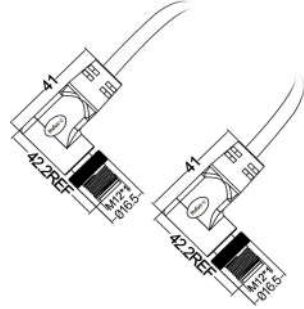

**Product photo/产品图**



**Part number/产品料号**

Pins/针数	Code/型	Part number("X" is length millimetre mm)/产品料号("X"表示长度, 单位毫米mm)	
		PVC jacket/PVC外被	PUR jacket/PUR外被
4pins/4针	S code/S型	-40°C~+105°C 12L01652-X	-40°C~+105°C 12L01653-X

**Pin assignment front view/针位分布前视图**

S code 4pins  
S型4针



**General data/常规数据**

Pins Numbers/针数	4pins/4针
Rated voltage/额定电压	630V
Rated current(40°C)/额定电流	12A
Standards/标准	IEC 61076-2-101
Termination/焊接方式	solder and over-mold/焊接和成型
Degree of protection/防护等级	IP67, IP68, IP69K
Wire gauge(mm²)/线规(平方数)	0.14mm²-0.75mm²
Wire gauge(AWG)/线号(平方数)	26AWG-18AWG
Mechanical operation/插拔次数	>100 mating cycles/大于100次
Contact resistance/接触电阻	≤5mΩ
Insulation resistance/绝缘电阻	≥100MΩ
Connector body/胶芯	TPU
Pins/端子	Brass with gold plated/黄铜镀金
Screw/螺丝	Brass with nickel plated/黄铜镀镍
Environmental compliance/环境符合标准	RoHs, Reach

## M12 S code male to female right angle molded cable, unshielded/M12, S型公头弯头对母头弯头连接线, 不带屏蔽

### Illustration/尺寸

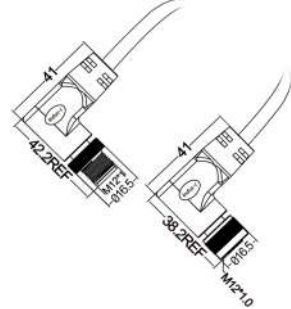

### Product photo/产品图



### Part number/产品料号

Pins/针数	Code/型	Part number("X" is length millimetre mm)/产品料号("X"表示长度, 单位毫米mm)	
		PVC jacket/PVC外被	PUR jacket/PUR外被
4pins/4针	S code/S型	-40°C~+105°C	-40°C~+105°C
		12L01654-X	12L01655-X

### Pin assignment front view/针位分布前视图

S code 4pins  
S型4针



S code 4pins  
S型4孔



### General data/常规数据

Pins Numbers/针数	4pins/4针
Rated voltage/额定电压	630V
Rated current(40°C)/额定电流	12A
Standards/标准	IEC 61076-2-101
Termination/焊接方式	solder and over-mold/焊接和成型
Degree of protection/防护等级	IP67, IP68, IP69K
Wire gauge(mm²)/线规(平方数)	0.14mm²-0.75mm²
Wire gauge(AWG)/线号(平方数)	26AWG-18AWG
Mechanical operation/插拔次数	>100 mating cycles/大于100次
Contact resistance/接触电阻	≤5mΩ
Insulation resistance/绝缘电阻	≥100MΩ
Connector body/胶芯	TPU
Male pin/公端子	Brass with gold plated/黄铜镀金
Female pin/母端子	Phosphorus copper with gold plated/磷铜镀金
Screw/螺丝	Brass with nickel plated/黄铜镀镍
Over-mold/成型	TPU
Environmental compliance/环境符合标准	RoHS, Reach

## M12 S code male right angle to female straight molded cable, unshielded/M12, S型公头弯头对母头直头成型式连接线, 不带屏蔽

### Illustration/尺寸

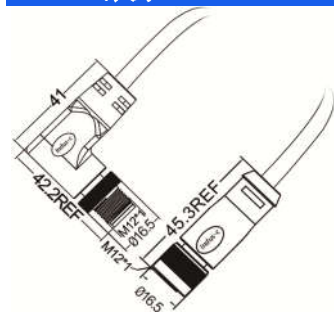

### Product photo/产品图



### Part number/产品料号

Pins/针数	Code/型	Part number("X" is length millimetre mm)/产品料号("X"表示长度, 单位毫米mm)	
		PVC jacket/PVC外被	PUR jacket/PUR外被
4pins/4针	S code/S型	-40°C~+105°C	-40°C~+105°C
		12L01656-X	12L01657-X

### Pin assignment front view/针位分布前视图

S code 4pins  
S型4针



S code 4pins  
S型4孔



### General data/常规数据

Pins Numbers/针数	4pins/4针
Rated voltage/额定电压	630V
Rated current(40°C)/额定电流	12A
Standards/标准	IEC 61076-2-101
Termination/焊接方式	solder and over-mold/焊接和成型
Degree of protection/防护等级	IP67, IP68, IP69K
Wire gauge(mm²)/线规(平方数)	0.14mm²-0.75mm²
Wire gauge(AWG)/线号(平方数)	26AWG-18AWG
Mechanical operation/插拔次数	>100 mating cycles/大于100次
Contact resistance/接触电阻	≤5mΩ
Insulation resistance/绝缘电阻	≥100MΩ
Connector body/胶芯	TPU
Male pin/公端子	Brass with gold plated/黄铜镀金
Female pin/母端子	Phosphorus copper with gold plated/磷铜镀金
Screw/螺丝	Brass with nickel plated/黄铜镀镍
Over-mold/成型	TPU
Environmental compliance/环境符合标准	RoHS, Reach

## M12 S code male straight to male right angle molded cable, unshielded/M12, S型公头直头对公头弯头连接线, 不带屏蔽

### Illustration/尺寸



### Product photo/产品图



### Part number/产品料号

Pins/针数	Code/型	Part number("X" is length millimetre mm)/产品料号("X"表示长度, 单位毫米mm)	
		PVC jacket/PVC外被	PUR jacket/PUR外被
4pins/4针	S code/S型	-40°C~+105°C 12L01658-X	-40°C~+105°C 12L01659-X

### Pin assignment front view/针位分布前视图

S code 4pins  
S型4针



### General data/常规数据

Pins Numbers/针数	4pins/4针
Rated voltage/额定电压	630V
Rated current(40°C)/额定电流	12A
Standards/标准	IEC 61076-2-101
Termination/焊接方式	solder and over-mold/焊接和成型
Degree of protection/防护等级	IP67, IP68, IP69K
Wire gauge(mm²)/线规(平方数)	0.14mm²-0.75mm²
Wire gauge(AWG)/线号(平方数)	26AWG-18AWG
Mechanical operation/插拔次数	>100 mating cycles/大于100次
Contact resistance/接触电阻	≤5mΩ
Insulation resistance/绝缘电阻	≥100MΩ
Connector body/胶芯	TPU
Pins/端子	Brass with gold plated/黄铜镀金
Screw/螺丝	Brass with nickel plated/黄铜镀镍
Environmental compliance/环境符合标准	RoHs, Reach

## M12 S code male to male straight molded cable, unshielded/M12, S型公头直头对公头直头连接线, 不带屏蔽

Illustration/尺寸

Product photo/产品图

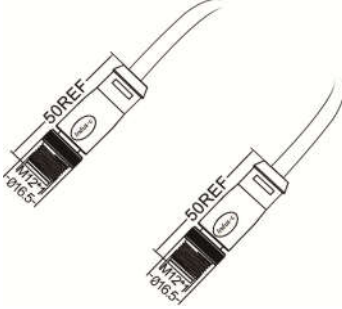

Part number/产品料号

Pins/针数	Code/型	Part number("X" is length millimetre mm)/产品料号("X"表示长度, 单位毫米mm)	
		PVC jacket/PVC外被	PUR jacket/PUR外被
4pins/4针	S code/S型	-40°C~+105°C 12L01660-X	-40°C~+105°C 12L01661-X

Pin assignment front view/针位分布前视图

S code 4pins  
S型4针



General data/常规数据

Pins Numbers/针数	4pins/4针
Rated voltage/额定电压	630V
Rated current(40°C)/额定电流	12A
Standards/标准	IEC 61076-2-101
Termination/焊接方式	solder and over-mold/焊接和成型
Degree of protection/防护等级	IP67, IP68, IP69K
Wire gauge(mm²)/线规(平方数)	0.14mm²-0.75mm²
Wire gauge(AWG)/线号(平方数)	26AWG-18AWG
Mechanical operation/插拔次数	>100 mating cycles/大于100次
Contact resistance/接触电阻	≤5mΩ
Insulation resistance/绝缘电阻	≥100MΩ
Connector body/胶芯	TPU
Pins/端子	Brass with gold plated/黄铜镀金
Screw/螺丝	Brass with nickel plated/黄铜镀镍
Environmental compliance/环境符合标准	RoHs, Reach

**M12 S code male straight to female right angle molded cable, unshielded/M12, S型公头直头对母头弯头连接线, 不带屏蔽**

**Illustration/尺寸**

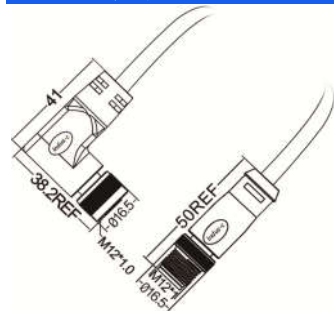

**Product photo/产品图**



**Part number/产品料号**

Pins/针数	Code/型	Part number("X" is length millimetre mm)/产品料号("X"表示长度, 单位毫米mm)	
		PVC jacket/PVC外被	PUR jacket/PUR外被
4pins/4针	S code/S型	-40°C~+105°C	-40°C~+105°C
		12L01662-X	12L01663-X

**Pin assignment front view/针位分布前视图**

S code 4pins  
S型4针



S code 4pins  
S型4孔



**General data/常规数据**

Pins Numbers/针数	4pins/4针
Rated voltage/额定电压	630V
Rated current(40°C)/额定电流	12A
Standards/标准	IEC 61076-2-101
Termination/焊接方式	solder and over-mold/焊接和成型
Degree of protection/防护等级	IP67, IP68, IP69K
Wire gauge(mm²)/线规(平方数)	0.14mm²-0.75mm²
Wire gauge(AWG)/线号(平方数)	26AWG-18AWG
Mechanical operation/插拔次数	>100 mating cycles/大于100次
Contact resistance/接触电阻	≤5mΩ
Insulation resistance/绝缘电阻	≥100MΩ
Connector body/胶芯	TPU
Male pin/公端子	Brass with gold plated/黄铜镀金
Female pin/母端子	Phosphorus copper with gold plated/磷铜镀金
Screw/螺丝	Brass with nickel plated/黄铜镀镍
Over-mold/成型	TPU
Environmental compliance/环境符合标准	RoHS, Reach

## M12 S code male to female straight molded cable, unshielded/M12, S型公头直头对母头直头连接线, 不带屏蔽

### Illustration/尺寸

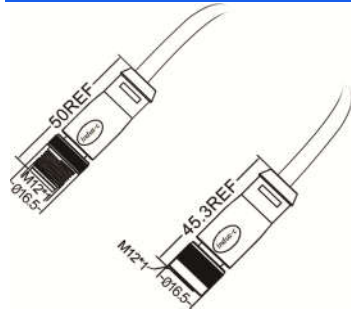

### Product photo/产品图



### Part number/产品料号

Pins/针数	Code/型	Part number("X" is length millimetre mm)/产品料号("X"表示长度, 单位毫米mm)	
		PVC jacket/PVC外被	PUR jacket/PUR外被
4pins/4针	S code/S型	-40°C~+105°C 12L01664-X	-40°C~+105°C 12L01665-X

### Pin assignment front view/针位分布前视图

S code 4pins  
S型4针



S code 4pins  
S型4孔



### General data/常规数据

Pins Numbers/针数	4pins/4针
Rated voltage/额定电压	630V
Rated current(40°C)/额定电流	12A
Standards/标准	IEC 61076-2-101
Termination/焊接方式	solder and over-mold/焊接和成型
Degree of protection/防护等级	IP67, IP68, IP69K
Wire gauge(mm²)/线规(平方数)	0.14mm²-0.75mm²
Wire gauge(AWG)/线号(平方数)	26AWG-18AWG
Mechanical operation/插拔次数	>100 mating cycles/大于100次
Contact resistance/接触电阻	≤5mΩ
Insulation resistance/绝缘电阻	≥100MΩ
Connector body/胶芯	TPU
Male pin/公端子	Brass with gold plated/黄铜镀金
Female pin/母端子	Phosphorus copper with gold plated/磷铜镀金
Screw/螺丝	Brass with nickel plated/黄铜镀镍
Over-mold/成型	TPU
Environmental compliance/环境符合标准	RoHS, Reach

## M12 S code female to female right angle molded cable, unshielded/M12, S型母头弯头对母头弯头连接线, 不带屏蔽

### Illustration/尺寸

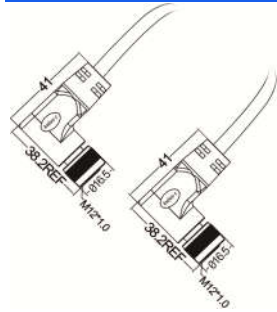

### Product photo/产品图



### Part number/产品料号

Pins/孔数	Code/型	Part number("X" is length millimetre mm)/产品料号("X"表示长度, 单位毫米mm)	
		PVC jacket/PVC外被	PUR jacket/PUR外被
4pins/4针	S code/S型	-40°C~+105°C	-40°C~+105°C
		12L01666-X	12L01667-X

### Pin assignment front view/孔位分布前视图

S code 4pins  
S型4孔



### General data/常规数据

Pins Numbers/孔数	4pins/4针
Rated voltage/额定电压	630V
Rated current(40°C)/额定电流	12A
Standards/标准	IEC 61076-2-101
Termination/焊接方式	solder and over-mold/焊接和成型
Degree of protection/防护等级	IP67, IP68, IP69K
Wire gauge(mm <sup>2</sup> )/线规(平方数)	0.14mm <sup>2</sup> -0.75mm <sup>2</sup>
Wire gauge(AWG)/线号(平方数)	26AWG-18AWG
Mechanical operation/插拔次数	>100 mating cycles/大于100次
Contact resistance/接触电阻	≤5mΩ
Insulation resistance/绝缘电阻	≥100MΩ
Connector body/胶芯	TPU
Pins/端子	Phosphorus copper with gold plated/磷铜镀金
Screw/螺丝	Brass with nickel plated/黄铜镀镍
Environmental compliance/环境符合标准	RoHs, Reach



**M12 S code female straight to female right angle molded cable, unshielded/M12, S型母头直头对母头弯头连接线, 不带屏蔽**

**Illustration/尺寸**

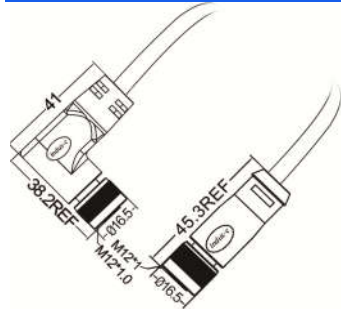

**Product photo/产品图**



**Part number/产品料号**

Pins/孔数	Code/型	Part number("X" is length millimetre mm)/产品料号("X"表示长度, 单位毫米mm)	
		PVC jacket/PVC外被	PUR jacket/PUR外被
4pins/4针	S code/S型	-40°C~+105°C 12L01668-X	-40°C~+105°C 12L01669-X

**Pin assignment front view/孔位分布前视图**

S code 4pins  
S型4孔



**General data/常规数据**

Pins Numbers/孔数	4pins/4针
Rated voltage/额定电压	630V
Rated current(40°C)/额定电流	12A
Standards/标准	IEC 61076-2-101
Termination/焊接方式	solder and over-mold/焊接和成型
Degree of protection/防护等级	IP67, IP68, IP69K
Wire gauge(mm²)/线规(平方数)	0.14mm²-0.75mm²
Wire gauge(AWG)/线号(平方数)	26AWG-18AWG
Mechanical operation/插拔次数	>100 mating cycles/大于100次
Contact resistance/接触电阻	≤5mΩ
Insulation resistance/绝缘电阻	≥100MΩ
Connector body/胶芯	TPU
Pins/端子	Phosphorus copper with gold plated/磷铜镀金
Screw/螺丝	Brass with nickel plated/黄铜镀镍
Environmental compliance/环境符合标准	RoHs, Reach

**M12 S code female to female straight molded cable, unshielded/M12, S型母头直头对母头直头连接线, 不带屏蔽**

**Illustration/尺寸**

**Product photo/产品图**

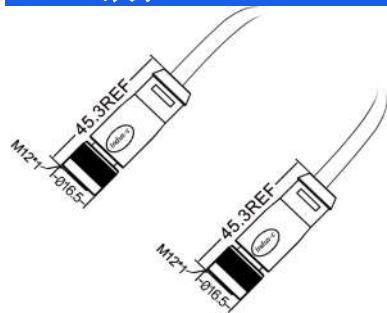

**Part number/产品料号**

Pins/孔数	Code/型	Part number("X" is length millimetre mm)/产品料号("X"表示长度, 单位毫米mm)	
		PVC jacket/PVC外被	PUR jacket/PUR外被
4pins/4针	S code/S型	-40°C~+105°C	-40°C~+105°C
		12L01670-X	12L01671-X

**Pin assignment front view/孔位分布前视图**

S code 4pins  
S型4孔



**General data/常规数据**

Pins Numbers/孔数	4pins/4针
Rated voltage/额定电压	630V
Rated current(40°C)/额定电流	12A
Standards/标准	IEC 61076-2-101
Termination/焊接方式	solder and over-mold/焊接和成型
Degree of protection/防护等级	IP67, IP68, IP69K
Wire gauge(mm²)/线规(平方数)	0.14mm²-0.75mm²
Wire gauge(AWG)/线号(平方数)	26AWG-18AWG
Mechanical operation/插拔次数	>100 mating cycles/大于100次
Contact resistance/接触电阻	≤5mΩ
Insulation resistance/绝缘电阻	≥100MΩ
Connector body/胶芯	TPU
Pins/端子	Phosphorus copper with gold plated/磷铜镀金
Screw/螺丝	Brass with nickel plated/黄铜镀镍
Environmental compliance/环境符合标准	RoHs, Reach

## M12 S code male to male right angle molded cable, shielded/M12, S型公头弯头对公头弯头连接线, 带屏蔽

Illustration/尺寸

Product photo/产品图

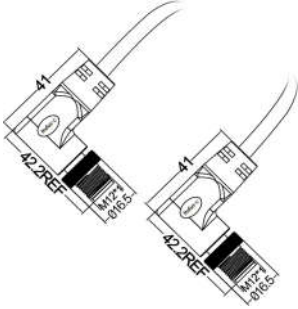

Part number/产品料号

Pins/针数	Code/型	Part number("X" is length millimetre mm)/产品料号("X"表示长度, 单位毫米mm)	
		PVC jacket/PVC外被	PUR jacket/PUR外被
4pins/4针	S code/S型	-40°C~+105°C	-40°C~+105°C
		12L01632-X	12L01633-X

Pin assignment front view/针位分布前视图

S code 4pins  
S型4针



General data/常规数据

Pins Numbers/针数	4pins/4针
Rated voltage/额定电压	630V
Rated current(40°C)/额定电流	12A
Standards/标准	IEC 61076-2-101
Termination/焊接方式	solder and over-mold/焊接和成型
Degree of protection/防护等级	IP67, IP68, IP69K
Wire gauge(mm²)/线规(平方数)	0.14mm²-0.75mm²
Wire gauge(AWG)/线号(平方数)	26AWG-18AWG
Mechanical operation/插拔次数	>100 mating cycles/大于100次
Contact resistance/接触电阻	≤5mΩ
Insulation resistance/绝缘电阻	≥100MΩ
Connector body/胶芯	TPU
Pins/端子	Brass with gold plated/黄铜镀金
Screw/螺丝	Brass with nickel plated/黄铜镀镍
Environmental compliance/环境符合标准	RoHs, Reach

## M12 S code male to female right angle molded cable, shielded/M12, S型公头弯头对母头弯头连接线, 带屏蔽

Illustration/尺寸

Product photo/产品图

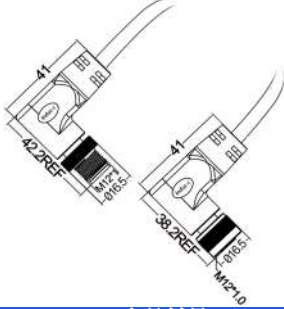

Part number/产品料号

Pins/针数	Code/型	Part number("X" is length millimetre mm)/产品料号("X"表示长度, 单位毫米mm)	
		PVC jacket/PVC外被	PUR jacket/PUR外被
4pins/4针	S code/S型	-40°C~+105°C	-40°C~+105°C
		12L01634-X	12L01635-X

Pin assignment front view/针位分布前视图

S code 4pins  
S型4针



S code 4pins  
S型4孔



General data/常规数据

Pins Numbers/针数	4pins/4针
Rated voltage/额定电压	630V
Rated current(40°C)/额定电流	12A
Standards/标准	IEC 61076-2-101
Termination/焊接方式	solder and over-mold/焊接和成型
Degree of protection/防护等级	IP67, IP68, IP69K
Wire gauge(mm²)/线规(平方数)	0.14mm²-0.75mm²
Wire gauge(AWG)/线号(平方数)	26AWG-18AWG
Mechanical operation/插拔次数	>100 mating cycles/大于100次
Contact resistance/接触电阻	≤5mΩ
Insulation resistance/绝缘电阻	≥100MΩ
Connector body/胶芯	TPU
Male pin/公端子	Brass with gold plated/黄铜镀金
Female pin/母端子	Phosphorus copper with gold plated/磷铜镀金
Screw/螺丝	Brass with nickel plated/黄铜镀镍
Over-mold/成型	TPU
Environmental compliance/环境符合标准	RoHS, Reach

## M12 S code male right angle to female straight molded cable, shielded/M12, S型公头弯头对母头直头成型式连接线, 带屏蔽

### Illustration/尺寸

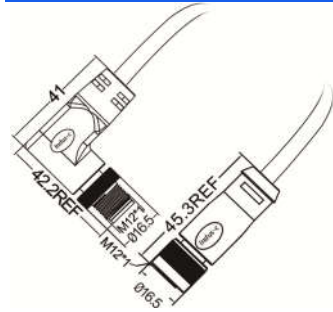

### Product photo/产品图



### Part number/产品料号

Pins/针数	Code/型	Part number("X" is length millimetre mm)/产品料号("X"表示长度, 单位毫米mm)	
		PVC jacket/PVC外被	PUR jacket/PUR外被
4pins/4针	S code/S型	-40°C~+105°C	-40°C~+105°C
		12L01636-X	12L01637-X

### Pin assignment front view/针位分布前视图

S code 4pins  
S型4针



S code 4pins  
S型4孔



### General data/常规数据

Pins Numbers/针数	4pins/4针
Rated voltage/额定电压	630V
Rated current(40°C)/额定电流	12A
Standards/标准	IEC 61076-2-101
Termination/焊接方式	solder and over-mold/焊接和成型
Degree of protection/防护等级	IP67, IP68, IP69K
Wire gauge(mm²)/线规(平方数)	0.14mm²-0.75mm²
Wire gauge(AWG)/线号(平方数)	26AWG-18AWG
Mechanical operation/插拔次数	>100 mating cycles/大于100次
Contact resistance/接触电阻	≤5mΩ
Insulation resistance/绝缘电阻	≥100MΩ
Connector body/胶芯	TPU
Male pin/公端子	Brass with gold plated/黄铜镀金
Female pin/母端子	Phosphorus copper with gold plated/磷铜镀金
Screw/螺丝	Brass with nickel plated/黄铜镀镍
Over-mold/成型	TPU
Environmental compliance/环境符合标准	RoHS, Reach

## M12 S code male straight to male right angle molded cable, shielded/M12, S型公头直头对公头弯头连接线, 带屏蔽

### Illustration/尺寸



### Product photo/产品图



### Part number/产品料号

Pins/针数	Code/型	Part number("X" is length millimetre mm)/产品料号("X"表示长度, 单位毫米mm)	
		PVC jacket/PVC外被	PUR jacket/PUR外被
4pins/4针	S code/S型	-40°C~+105°C 12L01638-X	-40°C~+105°C 12L01639-X

### Pin assignment front view/针位分布前视图

S code 4pins  
S型4针



### General data/常规数据

Pins Numbers/针数	4pins/4针
Rated voltage/额定电压	630V
Rated current(40°C)/额定电流	12A
Standards/标准	IEC 61076-2-101
Termination/焊接方式	solder and over-mold/焊接和成型
Degree of protection/防护等级	IP67, IP68, IP69K
Wire gauge(mm²)/线规(平方数)	0.14mm²-0.75mm²
Wire gauge(AWG)/线号(平方数)	26AWG-18AWG
Mechanical operation/插拔次数	>100 mating cycles/大于100次
Contact resistance/接触电阻	≤5mΩ
Insulation resistance/绝缘电阻	≥100MΩ
Connector body/胶芯	TPU
Pins/端子	Brass with gold plated/黄铜镀金
Screw/螺丝	Brass with nickel plated/黄铜镀镍
Environmental compliance/环境符合标准	RoHs, Reach

## M12 S code male to male straight molded cable, shielded/M12, S型公头直头对公头直头连接线, 带屏蔽

Illustration/尺寸

Product photo/产品图



Part number/产品料号

Pins/针数	Code/型	Part number("X" is length millimetre mm)/产品料号("X"表示长度, 单位毫米mm)	
		PVC jacket/PVC外被	PUR jacket/PUR外被
4pins/4针	S code/S型	-40°C~+105°C 12L01640-X	-40°C~+105°C 12L01641-X

Pin assignment front view/针位分布前视图

S code 4pins  
S型4针



General data/常规数据

Pins Numbers/针数	4pins/4针
Rated voltage/额定电压	630V
Rated current(40°C)/额定电流	12A
Standards/标准	IEC 61076-2-101
Termination/焊接方式	solder and over-mold/焊接和成型
Degree of protection/防护等级	IP67, IP68, IP69K
Wire gauge(mm²)/线规(平方数)	0.14mm²-0.75mm²
Wire gauge(AWG)/线号(平方数)	26AWG-18AWG
Mechanical operation/插拔次数	>100 mating cycles/大于100次
Contact resistance/接触电阻	≤5mΩ
Insulation resistance/绝缘电阻	≥100MΩ
Connector body/胶芯	TPU
Pins/端子	Brass with gold plated/黄铜镀金
Screw/螺丝	Brass with nickel plated/黄铜镀镍
Environmental compliance/环境符合标准	RoHs, Reach

## M12 S code male straight to female right angle molded cable, shielded/M12, S型公头直头对母头弯头连接线, 带屏蔽

Illustration/尺寸

Product photo/产品图

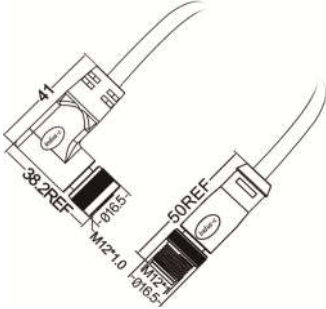

Part number/产品料号

Pins/针数	Code/型	Part number("X" is length millimetre mm)/产品料号("X"表示长度, 单位毫米mm)	
		PVC jacket/PVC外被	PUR jacket/PUR外被
4pins/4针	S code/S型	-40°C~+105°C	-40°C~+105°C
		12L01642-X	12L01643-X

Pin assignment front view/针位分布前视图

S code 4pins  
S型4针



S code 4pins  
S型4孔



General data/常规数据

Pins Numbers/针数	4pins/4针
Rated voltage/额定电压	630V
Rated current(40°C)/额定电流	12A
Standards/标准	IEC 61076-2-101
Termination/焊接方式	solder and over-mold/焊接和成型
Degree of protection/防护等级	IP67, IP68, IP69K
Wire gauge(mm²)/线规(平方数)	0.14mm²-0.75mm²
Wire gauge(AWG)/线号(平方数)	26AWG-18AWG
Mechanical operation/插拔次数	>100 mating cycles/大于100次
Contact resistance/接触电阻	≤5mΩ
Insulation resistance/绝缘电阻	≥100MΩ
Connector body/胶芯	TPU
Male pin/公端子	Brass with gold plated/黄铜镀金
Female pin/母端子	Phosphorus copper with gold plated/磷铜镀金
Screw/螺丝	Brass with nickel plated/黄铜镀镍
Over-mold/成型	TPU
Environmental compliance/环境符合标准	RoHS, Reach



## M12 S code male to female straight molded cable, shielded/M12, S型公头直头对母头直头连接线, 带屏蔽

Illustration/尺寸

Product photo/产品图

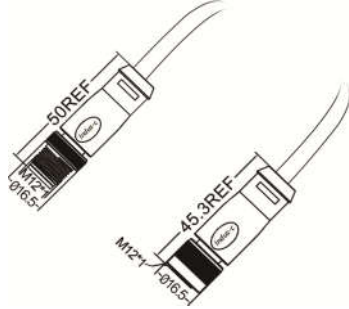

Part number/产品料号

Pins/针数	Code/型	Part number("X" is length millimetre mm)/产品料号("X"表示长度, 单位毫米mm)	
		PVC jacket/PVC外被	PUR jacket/PUR外被
4pins/4针	S code/S型	-40°C~+105°C 12L01644-X	-40°C~+105°C 12L01645-X

Pin assignment front view/针位分布前视图

S code 4pins  
S型4针



S code 4pins  
S型4孔



General data/常规数据

Pins Numbers/针数	4pins/4针
Rated voltage/额定电压	630V
Rated current(40°C)/额定电流	12A
Standards/标准	IEC 61076-2-101
Termination/焊接方式	solder and over-mold/焊接和成型
Degree of protection/防护等级	IP67, IP68, IP69K
Wire gauge(mm²)/线规(平方数)	0.14mm²-0.75mm²
Wire gauge(AWG)/线号(平方数)	26AWG-18AWG
Mechanical operation/插拔次数	>100 mating cycles/大于100次
Contact resistance/接触电阻	≤5mΩ
Insulation resistance/绝缘电阻	≥100MΩ
Connector body/胶芯	TPU
Male pin/公端子	Brass with gold plated/黄铜镀金
Female pin/母端子	Phosphorus copper with gold plated/磷铜镀金
Screw/螺丝	Brass with nickel plated/黄铜镀镍
Over-mold/成型	TPU
Environmental compliance/环境符合标准	RoHS, Reach

## M12 S code female to female right angle molded cable, shielded/M12, S型母头弯头对母头弯头连接线, 带屏蔽

### Illustration/尺寸

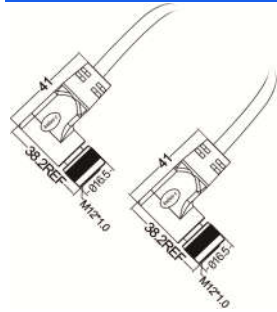

### Product photo/产品图



### Part number/产品料号

Pins/孔数	Code/型	Part number("X" is length millimetre mm)/产品料号("X"表示长度, 单位毫米mm)	
		PVC jacket/PVC外被	PUR jacket/PUR外被
4pins/4针	S code/S型	-40°C~+105°C	-40°C~+105°C
		12L01646-X	12L01647-X

### Pin assignment front view/孔位分布前视图

S code 4pins  
S型4孔



### General data/常规数据

Pins Numbers/孔数	4pins/4针
Rated voltage/额定电压	630V
Rated current(40°C)/额定电流	12A
Standards/标准	IEC 61076-2-101
Termination/焊接方式	solder and over-mold/焊接和成型
Degree of protection/防护等级	IP67, IP68, IP69K
Wire gauge(mm²)/线规(平方数)	0.14mm²-0.75mm²
Wire gauge(AWG)/线号(平方数)	26AWG-18AWG
Mechanical operation/插拔次数	>100 mating cycles/大于100次
Contact resistance/接触电阻	≤5mΩ
Insulation resistance/绝缘电阻	≥100MΩ
Connector body/胶芯	TPU
Pins/端子	Phosphorus copper with gold plated/磷铜镀金
Screw/螺丝	Brass with nickel plated/黄铜镀镍
Environmental compliance/环境符合标准	RoHs, Reach

## M12 S code female straight to female right angle molded cable, shielded/M12, S型母头直头对母头弯头连接线, 带屏蔽

### Illustration/尺寸

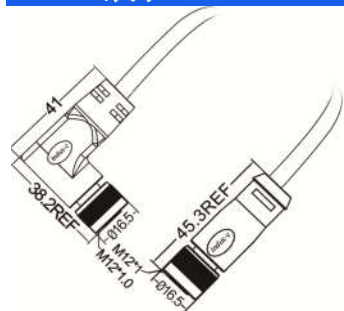

### Product photo/产品图



### Part number/产品料号

Pins/孔数	Code/型	Part number("X" is length millimetre mm)/产品料号("X"表示长度, 单位毫米mm)	
		PVC jacket/PVC外被	PUR jacket/PUR外被
4pins/4针	S code/S型	-40°C~+105°C 12L01648-X	-40°C~+105°C 12L01649-X

### Pin assignment front view/孔位分布前视图

S code 4pins  
S型4孔



### General data/常规数据

Pins Numbers/孔数	4pins/4针
Rated voltage/额定电压	630V
Rated current(40°C)/额定电流	12A
Standards/标准	IEC 61076-2-101
Termination/焊接方式	solder and over-mold/焊接和成型
Degree of protection/防护等级	IP67, IP68, IP69K
Wire gauge(mm²)/线规(平方数)	0.14mm²-0.75mm²
Wire gauge(AWG)/线号(平方数)	26AWG-18AWG
Mechanical operation/插拔次数	>100 mating cycles/大于100次
Contact resistance/接触电阻	≤5mΩ
Insulation resistance/绝缘电阻	≥100MΩ
Connector body/胶芯	TPU
Pins/端子	Phosphorus copper with gold plated/磷铜镀金
Screw/螺丝	Brass with nickel plated/黄铜镀镍
Environmental compliance/环境符合标准	RoHs, Reach

## M12 S code female to female straight molded cable, shielded/M12, S型母头直头对母头直头连接线, 带屏蔽

Illustration/尺寸

Product photo/产品图

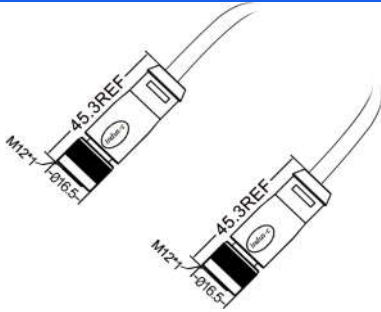

Part number/产品料号

Pins/孔数	Code/型	Part number("X" is length millimetre mm)/产品料号("X"表示长度, 单位毫米mm)	
		PVC jacket/PVC外被	PUR jacket/PUR外被
4pins/4针	S code/S型	-40°C~+105°C	-40°C~+105°C
		12L01650-X	12L01651-X

Pin assignment front view/孔位分布前视图

S code 4pins  
S型4孔



General data/常规数据

Pins Numbers/孔数	4pins/4针
Rated voltage/额定电压	630V
Rated current(40°C)/额定电流	12A
Standards/标准	IEC 61076-2-101
Termination/焊接方式	solder and over-mold/焊接和成型
Degree of protection/防护等级	IP67, IP68, IP69K
Wire gauge(mm²)/线规(平方数)	0.14mm²-0.75mm²
Wire gauge(AWG)/线号(平方数)	26AWG-18AWG
Mechanical operation/插拔次数	>100 mating cycles/大于100次
Contact resistance/接触电阻	≤5mΩ
Insulation resistance/绝缘电阻	≥100MΩ
Connector body/胶芯	TPU
Pins/端子	Phosphorus copper with gold plated/磷铜镀金
Screw/螺丝	Brass with nickel plated/黄铜镀镍
Environmental compliance/环境符合标准	RoHs, Reach